

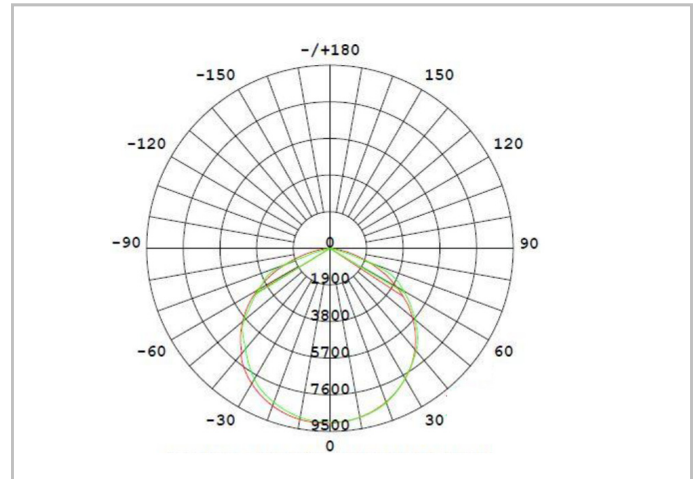

Product Specifications

Material: Aluminum Alloy + PC Cover.
Finish: Silver Grey.
Optics: 25°
Luminous Efficiency: 137 lm/W
Source: Philips Lumileds LED
Power factor: ≥98%
Electrical: 120V AC.
Operating Temperature: -15°C 40°C
Color Rendering Index (CRI): ≥80
IP Rating: IP65

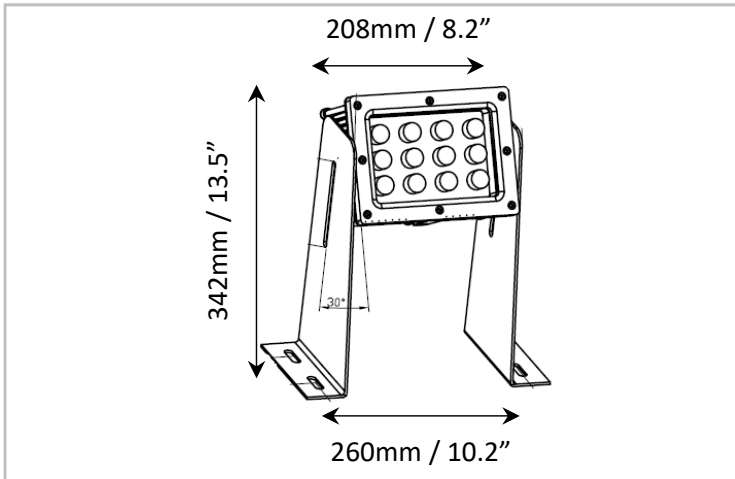

Ordering information

Ordering Example: IL-DUSQ12-1-1-1-1



Series	Power	Color Temp	Finish	Beam	Optional
IL-DUSQ12	12	1 = 3000K 2 = 4000K 3 = 5000K 3 = 6000K	1 = Silver Grey	1 = 25° 2 = Wide Beam	1 = Dimming 1-10V